

# Case Studies of Alternative Climate Management for Hot-Humid and Marine Climates

Shin Maekawa, Ph.D. P.E.



**The Getty Conservation Institute**  
1200 Getty Center Drive, Suite 700  
Los Angeles, CA 90049-1684  
[smaekawa@getty.edu](mailto:smaekawa@getty.edu)  
[www.getty.edu](http://www.getty.edu)

# Climate Zone Definition

- Building energy demand
  - How hot or cold it is and how much energy may be needed to keep buildings cool or warm.
- Thermal criteria
  - Cooling Degree-Day (CDD) and Heating Degree-Day (HDD)
  - 8 thermal climate zones
    - Very Hot (1), Hot (2), Warm (3), Mix (4), Cool (5), Cold (6), Very Cold(7), and Subarctic (8)
- Moisture criteria
  - 3 moisture zones
    - Humid (A), Dry (B), and Marine (C)
- Combine thermal and moisture criteria
  - Very Hot-Humid (1A), Hot-Humid (2A), Mix-Marine (4C),.....

Zone No.	Climate Zone Name	Thermal Criteria	Representative U.S. City
1	Very Hot	$5000 < \text{CDD}_{10^{\circ}\text{C}}$	Miami, FL
2	Hot	$3500 < \text{CDD}_{10^{\circ}\text{C}} \leq 5000$	Houston, TX and Phoenix, AZ
3	Warm	$2500 < \text{CDD}_{10^{\circ}\text{C}} \leq 3500$	Memphis, TN, El Paso, TX, and Los Angeles, CA
4	Mixed	$\text{CDD}_{10^{\circ}\text{C}} \leq 2500$ AND $\text{HDD}_{18^{\circ}\text{C}} \leq 3000$	Baltimore, MD, Albuquerque, NM, Salem, OR, and New York, NY
5	Cool	$3000 < \text{HDD}_{18^{\circ}\text{C}} \leq 4000$	Chicago, IL, Boise, ID
6	Cold	$4000 < \text{HDD}_{18^{\circ}\text{C}} \leq 5000$	Burlington, VT and Helena, MT
7	Very Cold	$5000 < \text{HDD}_{18^{\circ}\text{C}} \leq 7000$	Duluth, MN
8	Subarctic	$7000 < \text{HDD}_{18^{\circ}\text{C}}$	Fairbanks, AK

Briggs, Lucas, and Taylor, 2002

# U. S. Map of Annual Precipitation



# The U.S. Map of Climate Zones

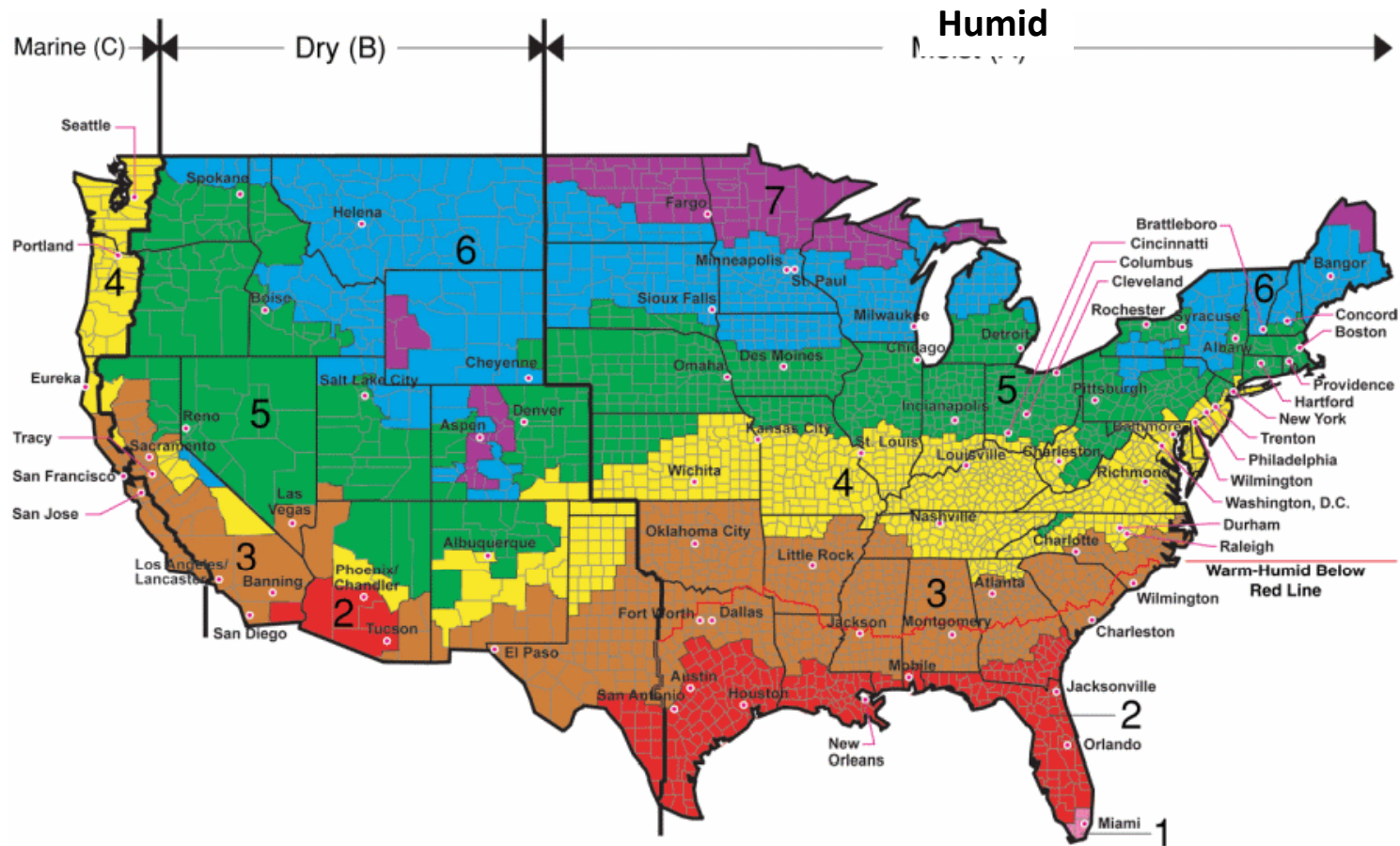

All of Alaska in Zone 7 except for the following Boroughs in Zone 8: Bethel, Dellingham, Fairbanks, N. Star, Nome North Slope, Northwest Arctic, Southeast Fairbanks, Wade Hampton, and Yukon-Koyukuk

Zone 1 includes: Hawaii, Guam, Puerto Rico, and the Virgin Islands

Source: Modified based on a drawing by Building Science Consulting

# World Map of Annual Precipitation

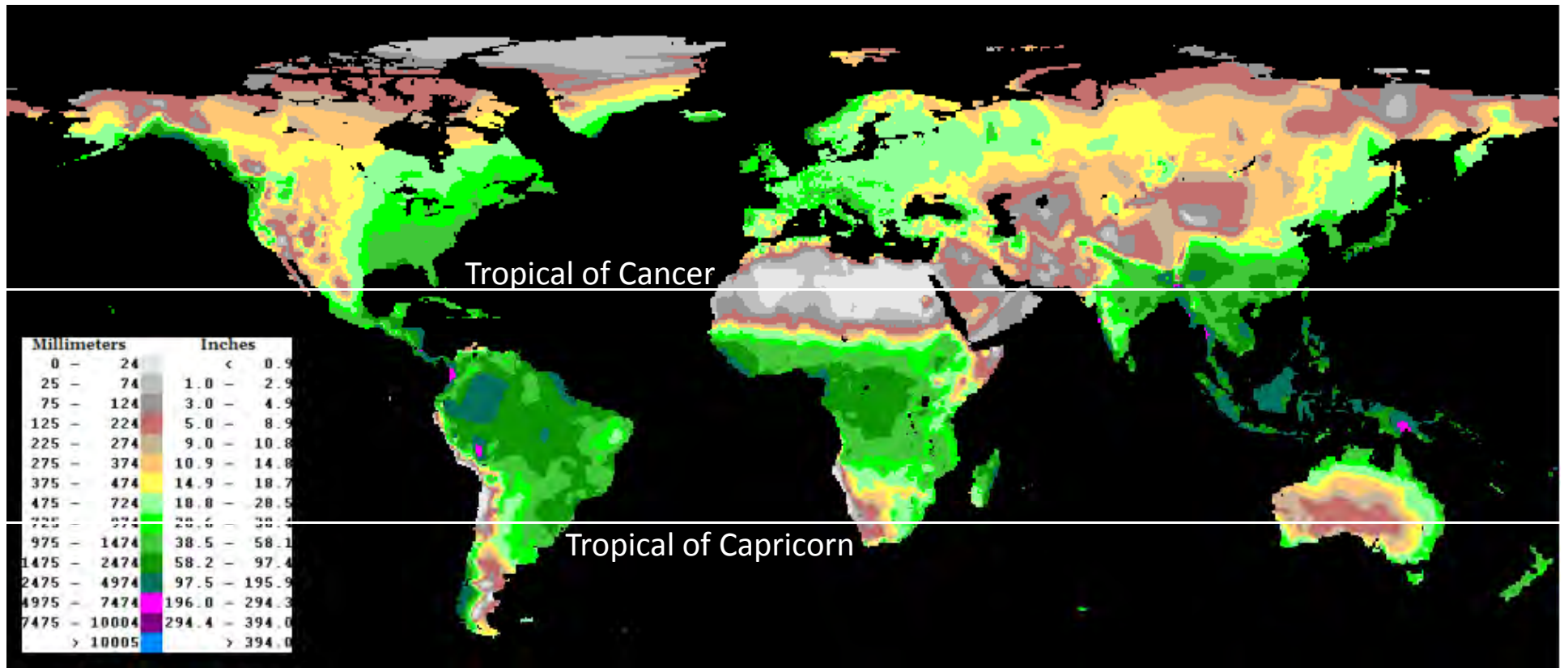

Source: USGS

# Climate Requirements from Collection Preservation and Priority in Hot-Humid and Marine Climate

- Collection Deterioration
  - Biological
    - Less than 75% RH (Control D)
  - Mechanical
    - Short-term fluctuations
      - $\pm 5\%$  RH &  $\pm 2\text{K}$  (AA) ,  $\pm 10\%$  RH &  $\pm 2\text{K}$ , ... 25% - 75% RH (D)
    - Seasonal fluctuations
  - Chemical
    - Lower temperatures and lower relative humidity

# Climate Requirements from Comfort only for human occupancy

- Thermal comfort
  - Predicted Mean Vote (PMV) and Percentage People Dissatisfied (PPD)
    - Physical - temperature, humidity, air velocity, and radiant temperature
    - Behavioral -physical activities and clothing
  - Adoptive comfort
    - psychological
- Indoor Air Quality
  - Ventilation for controlling CO<sub>2</sub> and VOCs
- Others
  - Noise and vibrations
  - Light



# Conventional Air-Conditioning

- Cooling and Dehumidification (+ Reheat)
- Many buildings pre-date A/C
  - Building material thermal and hygric property
  - Building envelope – too leaky
  - Space distribution – too big or too small
  - Design issues – equipment locations
  - Performance issues – not enough dehumidification
  - Maintenance issues – accessibility of equipment
  - Economical issues – capital and energy costs

# Alternative Strategy

## Integrated approach

- Assessments
  - Building envelope, collection, and environment
- Strategy development
  - Building envelope & source moisture and heat control
  - Space management
  - Mechanical system
- Implementation
  - Installation, commissioning
- Monitoring and improvements/maintenance - **Iterations**
  - **Re-assessment**
  - **Improvement design & implementation**

# Envelope and Landscape Improvements

- Source heat and moisture control
- Air-tightening of envelope
- Thermal insulation – if possible

# Use of Space

- Not occupied
  - storages
- Regularly accessed
  - Archives
  - Storages with temporal work space
- Occupied/visited
  - Offices
  - Guided or self-guided tours

# Psychrometry

(The science of studying the thermodynamic properties of moist air.)

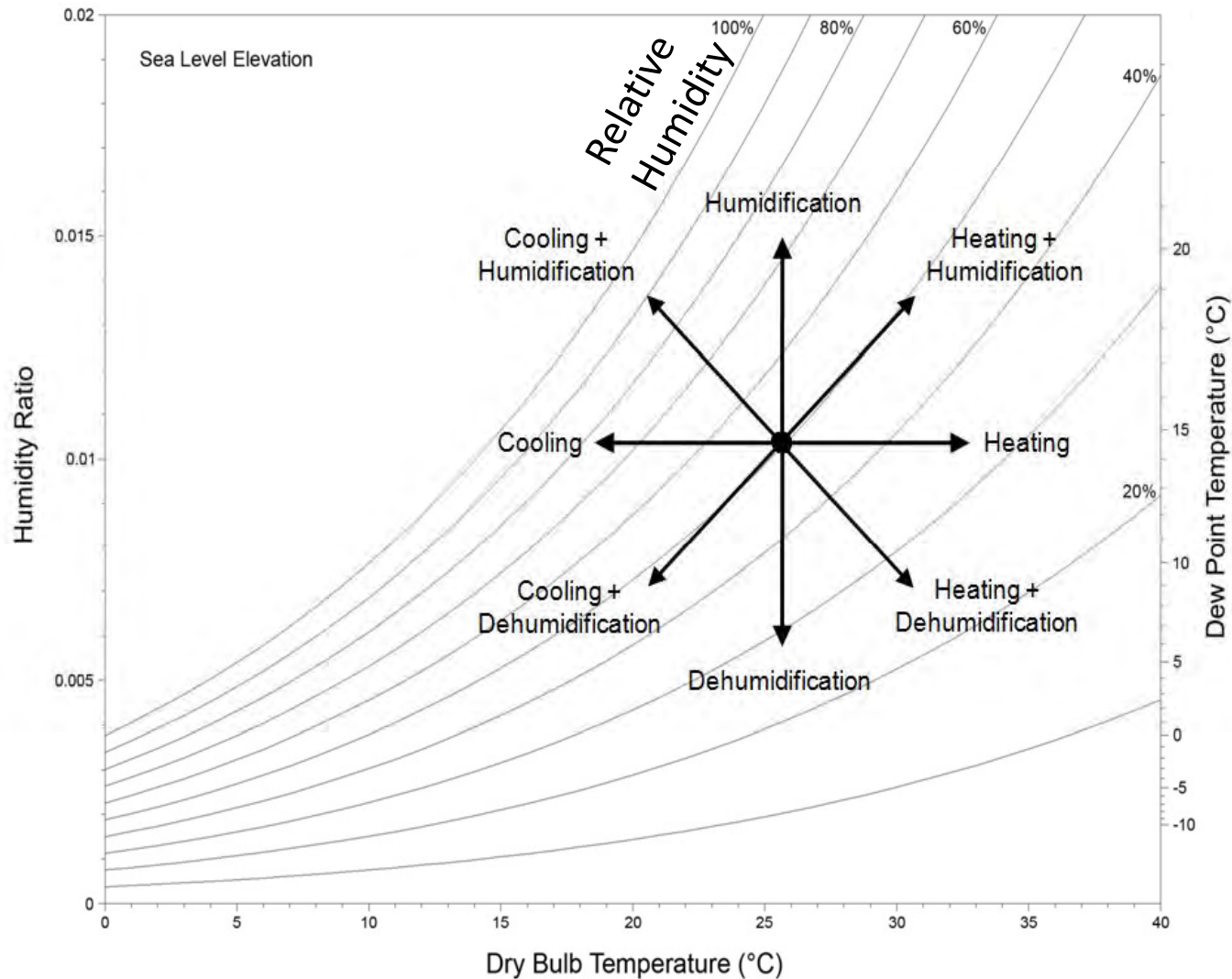

# Cooled vs. Non-Cooled Building during equipment or power failure

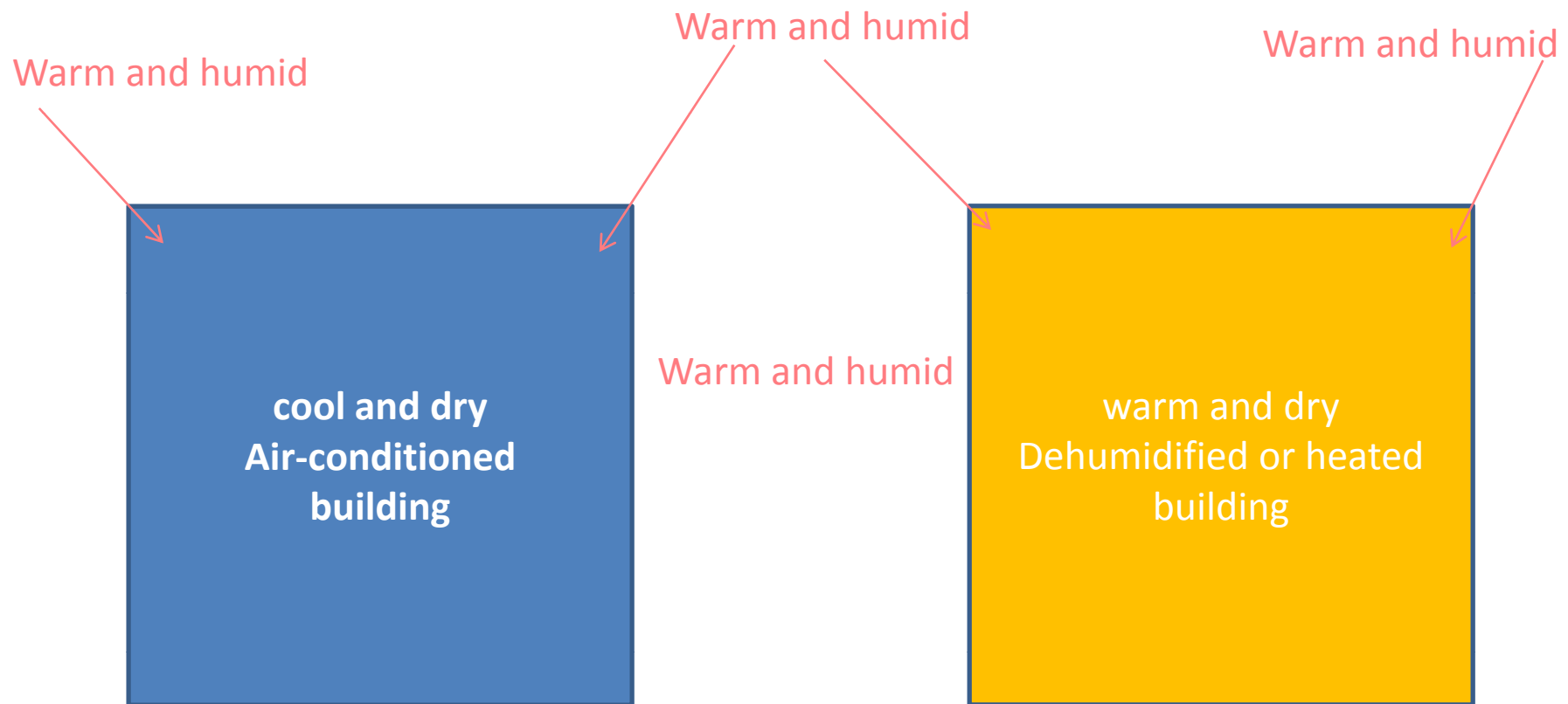

# Mechanical system

- Dilution ventilation
  - Supply and exhaust fans
  - Filter at supply
- Conservation heating
- Dehumidification
- Humidity control
  - Humidity sensors
    - Inside (climate zones)
    - Outside (ventilation)

# Modes of Operation

Mode	Room RH	Outside RH
Idle (standby)	Below set point	Any value
Ventilation	Above set point	Below set point
Dehumidification or Conservation Heating	Above set point	Above set point



Case Study	Climate	Building	Collection	Access
Museum Storage Belém (Brazil)	Very Hot-Humid (1A)	Hollow brick Class III – D Modern 270 m <sup>2</sup>	Mixed ethnographic collection consisting of objects used in agriculture, fishing/hunting, food processing, ceremonies, and celebrations - materials include plant fibers, wood, seeds, and feathers	Limited access by conservators
Library of historic house Rio de Janeiro (Brazil)	Very Hot-Humid (1A)	Heavy masonry Class – C or D Historic 165 m <sup>2</sup> (Five Rooms)	Book collection, artwork, and furniture	Up to 50 school children
Museum Storage Tenerife, (Spain)	Hot-Humid (2A)	Light masonry Class III - D Modern 440 m <sup>2</sup> (Four Rooms)	Mixed collection of folk artifacts such as agricultural/small industry objects, textiles, pottery, basketry, and furniture - materials include organics (e.g., sapwood, paper, leather, hide, sticks, leaves) and metals	Periodic light work by conservators
Historic house Jekyll Island, GA (United States)	Hot-Humid (2A)	In-situ casted concrete Class IV – C or D Historic Basement, 1st & 2nd Floors: 279 m <sup>2</sup> each / Attic: 214 m <sup>2</sup> (All floors unfinished)	Historic interior	Limited tours
Historic house Beijing, China	Mix-Humid (4A)	Post and beam assembly with masonry infill Class IV – C or D Historic 224 m <sup>2</sup>	Interior decorations such as polished iron wood framing, silk embroidery, bamboo marquetry, wood relief, paintings and calligraphy mounted on wallpaper, mural paintings on silk, painted wooden surfaces	Limited number of guided tours
Archive Tenerife (Spain)	Mix-Marine (4C)	Heavy masonry Class IV – C or D Historic 25.4 m <sup>2</sup> (Two Rooms)	Bound and unbound archival documents	Regular access by archivist

# Emilio Goeldi Museum, Belem

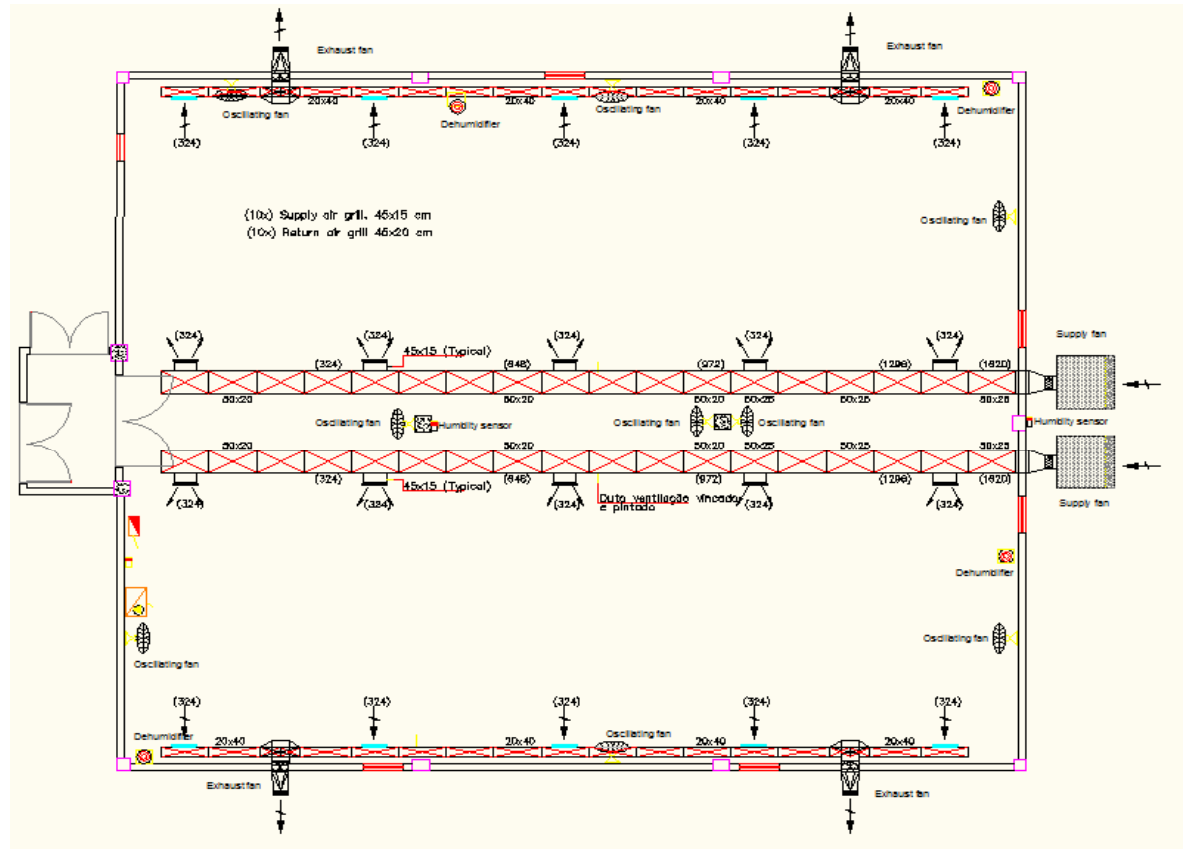

# Historic House Museum, Rio de Janeiro

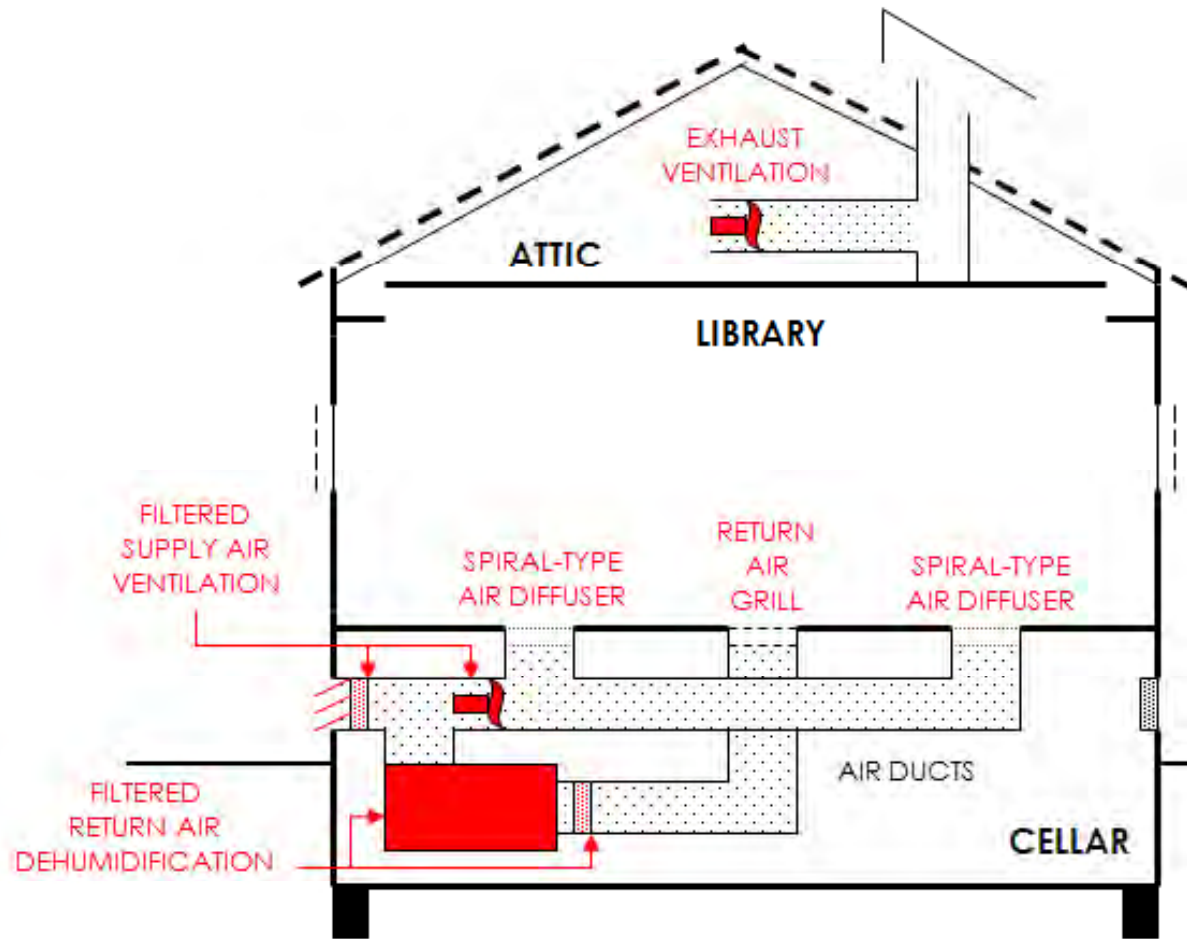

# Museum Storage, Tenerife

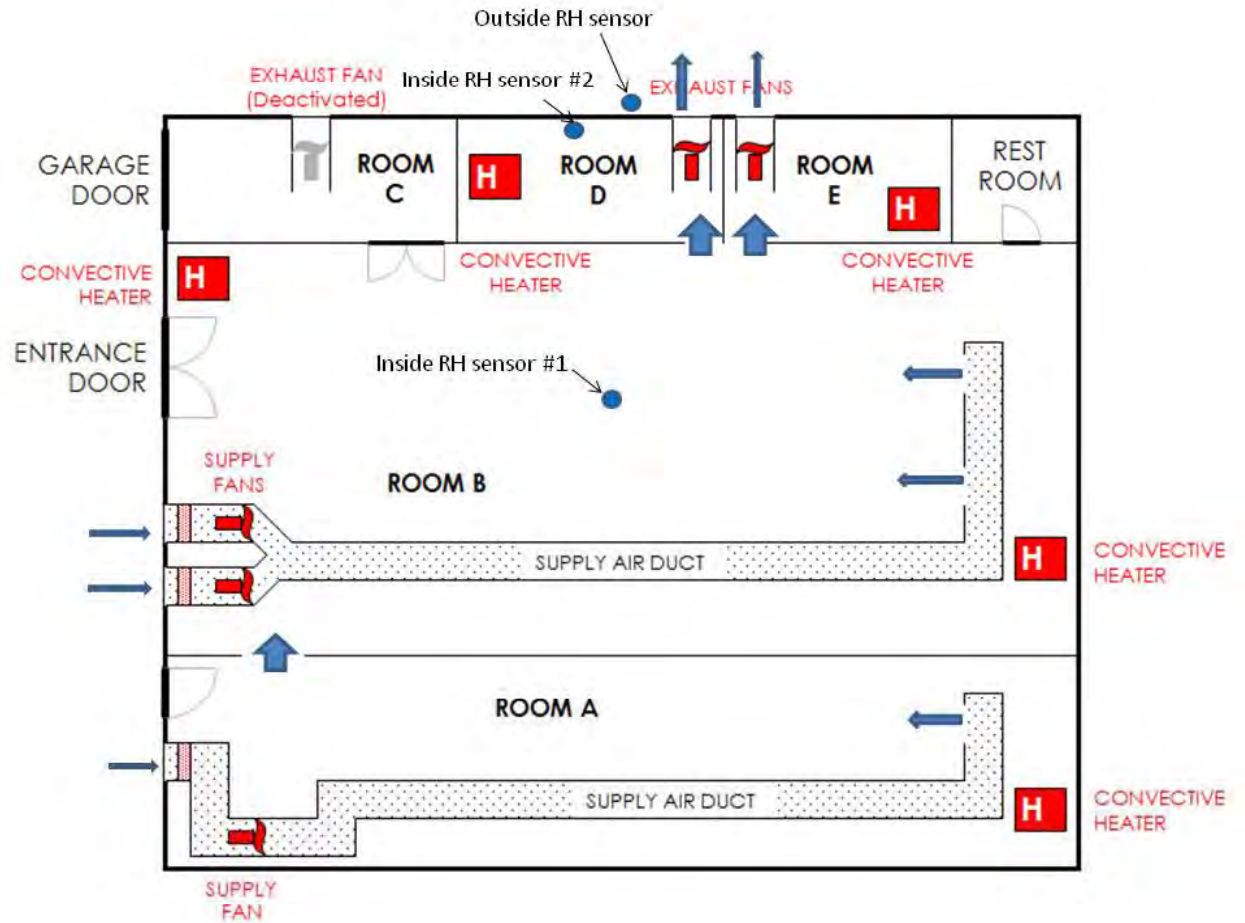

# Municipal archive, La Laguna, Tenerife

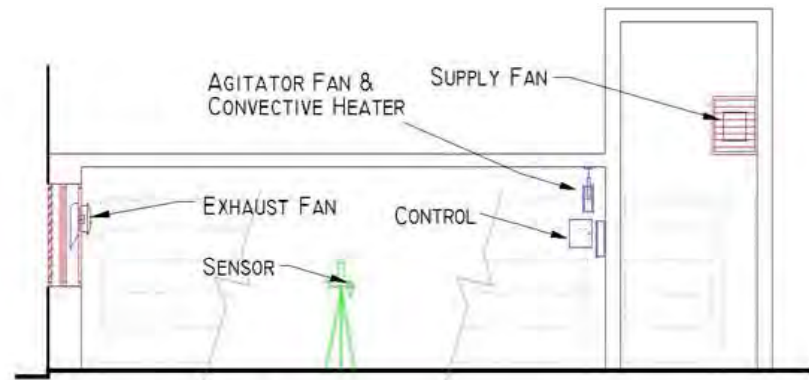

SECTION AA AFTER INSTALLATION OF CLIMATE CONTROL SYSTEM

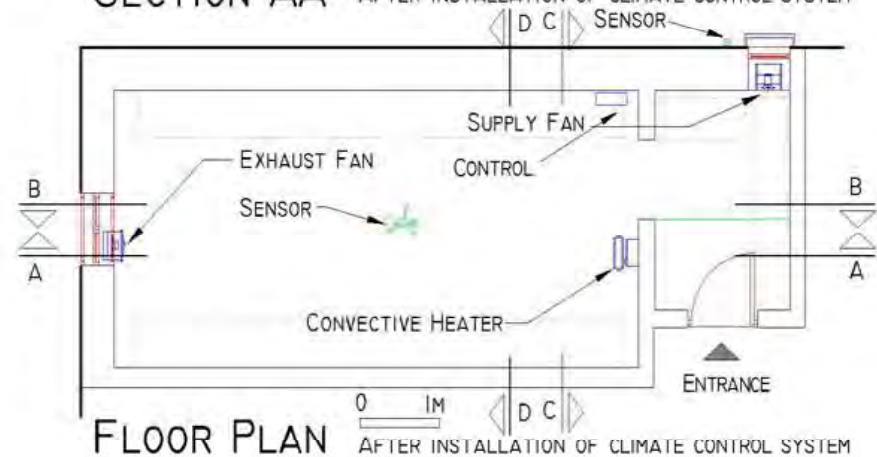

# Historic House Museum in Beijing, China

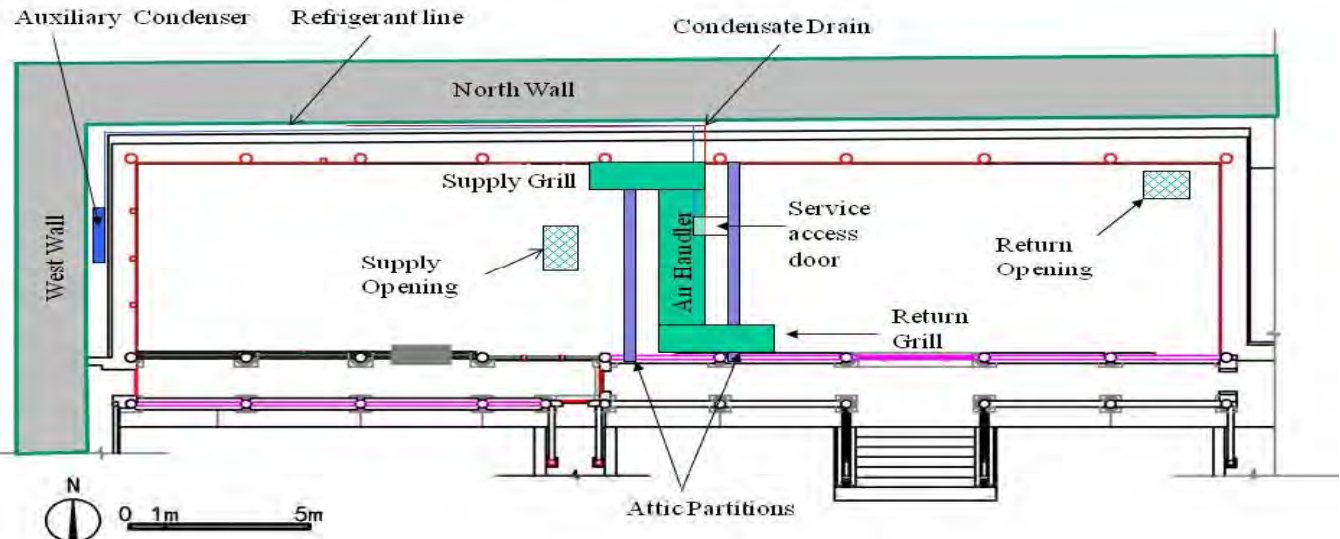
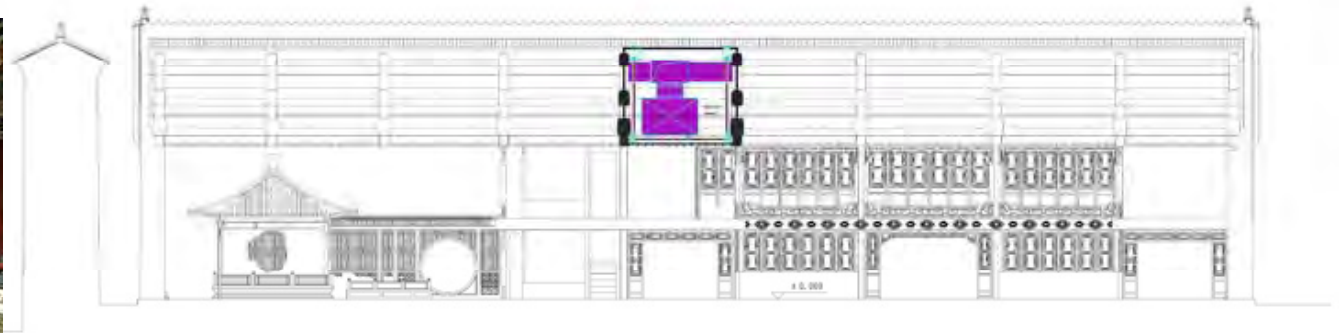

Case Study Climate	Non-Mechanical Strategies	Occupancy Strategy	Mechanical Strategy	Degree of climate control	Costs
Museum Storage Belém (Brazil) 1A	Building envelope tightening/ vestibule area / attic insulation / Paved surrounding area/ perforated compact shelving walls	Limited Access	Ventilation Dehumidification	RH: 55 ± 5% AA-A AT: 30 - 33°C	Capital: \$53 / m <sup>2</sup> Energy: \$2.04 /m <sup>2</sup>
Historic House Rio de Janeiro (Brazil) 1A	Repaired building envelope / closed windows and doors / repaired bookcase doors / modified visitor pathway	Guided Tours	Ventilation, Dehumidification (Electric Reheat) Limited Cooling	RH: 60 ± 5% AA-A AT: 22-28°C	Capital: \$ 336/ m <sup>2</sup> Energy: \$ /m <sup>2</sup> /yr
Museum Storage Tenerife, (Spain) 2A	Sealed external windows and doors/ sealed gaps in doors / Installed air- tight door in restroom	Limited Access	Ventilation Heating	RH: 60 ± 5% AA-A AT: 18 - 30°C	Capital: 61/m <sup>2</sup> Energy: \$6.6m <sup>2</sup> /yr
Historic House Jekyll Island, GA 2A	Repaired building envelope / sealed gaps in roof / Improved drainage of area surrounding building	Guided Tours	Ventilation Heating or Dehumidification	Basement RH: 38 - 76% Attic RH: 32 - 80% Basement AT: 10 - 32°C Attic AT: 4 - 38°C	Capital: \$28/m <sup>2</sup> Energy: 2.2 - 4.6/m <sup>2</sup>
Historic House Beijing (China) 4A	Shaded double-glazed windows/ Sealed gaps in doors and attic	Guided Tours	Recirculation Dehumidification Limited Cooling	RH: 50 ± 5% (summer) AA-A 40 – 55 % (seasonal variation) AT: 0 - 28.5°C	Capital \$308 / m <sup>2</sup> Energy: \$20.2m <sup>2</sup> /yr
Archive Tenerife (Spain) 4C	Vestibule area/ removed internal door / filled window and door gaps	Limited Access	Ventilation Heating	RH: 65± 5% AA-A AT: 17-27°C	Capital: \$98/m <sup>2</sup> Energy: \$0.86/m <sup>2</sup>

# Costs of HVAC Systems

(from E. Conrad March 2006 NARA Conference)

## Capital cost

- Heating only \$105 /m<sup>2</sup> (\$10/ft<sup>2</sup>)
- Basic A/C \$262 /m<sup>2</sup> (\$25/ft<sup>2</sup>)
- Climate control \$525 /m<sup>2</sup> (\$50/ft<sup>2</sup>)

## Energy cost

- Church \$8.2 /m<sup>2</sup>/year (\$0.75 /ft<sup>2</sup>/year)
- House \$14 /m<sup>2</sup>/year (\$ 1.25/ft<sup>2</sup>/year)
- Office \$19 /m<sup>2</sup>/year (\$ 1.75 /ft<sup>2</sup>/year)
- Museum \$33 /m<sup>2</sup>/year (\$ 3.00 /ft<sup>2</sup>/year)



# Conclusions

- Integrated project approach
  - the assessment, strategy development, implementation, monitoring, maintenance, re-assessment, and improvement.
- Sensible climate management can be achieved through
  - Non-mechanical controls
    - Building envelope tightening
    - source moisture and heat removal
  - Define space use for economical system
    - Conservation environment and comfort.
  - Installation of mechanical system
    - Humidity control
- Relative humidity control, while letting temperature to float, will allow significant reductions in both the capital and energy costs.

# Conservation-Focused Climate Management for Cultural Institutions in Hot-Humid and Marine Climate Regions

By Shin Maekawa, Vincent Beltran, and Michael Henry  
planned publication in 2013

## Contents

- Energy demand based climate definition
- Implications for collections and buildings
- Implication of comfort & health
- Psychrometric strategies for climate management
- Building and operational strategies for environmental management
- Mechanical approaches for climate management
- Designing and implementing conservation-focused climate management systems
- 6 Case studies

# Related Publications

Case Study Climate	Downloadable Conference or Journal Publications on the Getty Web Site
Museum Storage, Belém (Brazil) 1A	<a href="http://www.getty.edu/conservation/science/climate/goeldi_ashrae.pdf">http://www.getty.edu/conservation/science/climate/goeldi_ashrae.pdf</a>
Historic House, Rio de Janeiro (Brazil) 1A	<a href="http://www.getty.edu/conservation/science/climate/barbosa_plea.pdf">http://www.getty.edu/conservation/science/climate/barbosa_plea.pdf</a> <a href="http://www.getty.edu/conservation/publications/newsletters/22_1/news_in_cons1.html">http://www.getty.edu/conservation/publications/newsletters/22_1/news_in_cons1.html</a>
Museum Storage, Tenerife, (Spain) 2A	<a href="http://www.getty.edu/conservation/science/climate/valle_de_guerra_PLEA_2006.pdf">http://www.getty.edu/conservation/science/climate/valle_de_guerra_PLEA_2006.pdf</a>
Historic House, Jekyll Island, GA 2A	<a href="http://www.getty.edu/conservation/science/climate/hollybourne_cottage_APT.pdf">http://www.getty.edu/conservation/science/climate/hollybourne_cottage_APT.pdf</a> <a href="http://www.getty.edu/conservation/publications/pdf_publications/iaq453.pdf">http://www.getty.edu/conservation/publications/pdf_publications/iaq453.pdf</a>
Historic House, Beijing (China) 4A	<a href="http://www.getty.edu/conservation/science/climate/juanqinzhai.pdf">http://www.getty.edu/conservation/science/climate/juanqinzhai.pdf</a>
Archive ,Tenerife (Spain) 4C	<a href="http://www.getty.edu/conservation/publications/pdf_publications/icomcc1.pdf">http://www.getty.edu/conservation/publications/pdf_publications/icomcc1.pdf</a> <a href="http://www.getty.edu/conservation/publications/pdf_publications/plea.pdf">http://www.getty.edu/conservation/publications/pdf_publications/plea.pdf</a>